

SOFAR

USER MANUAL

SOFAR BTS 5K

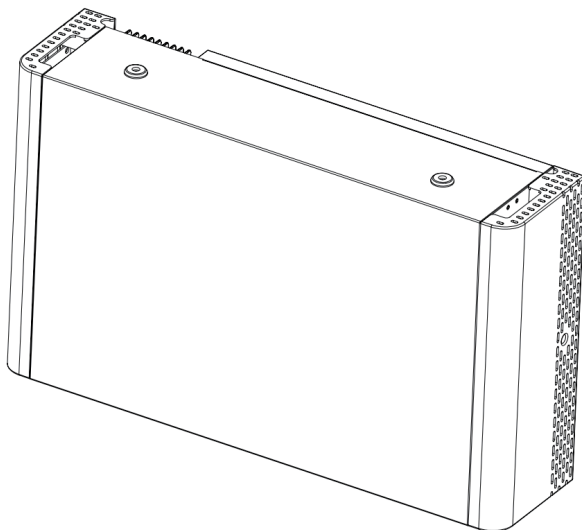

Shenzhen SOFARSOLAR Co., Ltd

Contents

Preface	III
1. Basic Safety Information	1
1.1. Requirement for Installation and Maintenance	1
1.2. Description of safety information symbols	4
2. Product Introduction	6
2.1. Product overview	6
2.2. Product Model Description	8
2.3. Product Appearance	7
2.4. Product label	8
3. Product Installation	11
3.1. Checking Before Installation	9
3.2. Preparation for Installation Tools	13
3.3. Installation environment	14
3.4. Installation Space	15
3.5. Battery module installation	16
4. Electrical Connection	19
4.1. Electrical Connection	19
4.1.1 Protection grounding cable connection	19
4.1.2 Power cables connection	20
4.1.3 Communication cable connection	22
4.2. Install the protective cover	23
5. Commissioning	25
5.1. Double Check	25
5.2. Electrify for the First Time (Important)	25
5.3. Software Update and Battery monitoring	25
5.4. Battery Powered Off	27
6. Trouble shooting and maintenance	28
6.1. Troubleshooting	28
6.2. Daily Maintenance	29
6.3. Battery Module Storage Requirements and Power Supply	29

7. Technical Parameters	31
8. Manufacturer's Warranty and Liability Terms	33

Preface

Notice

The purchased products, services and features are governed by the commercial contract made by the Company. All or part of the products and features described in this document may not be within the purchase scope. Except as otherwise agreed herein, no representations or warranties, express or implied, are made as to the contents of this document.

Save this Instruction

This manual must be considered as an integral part of the equipment. Customer can print the electronic version to hard copy and keeping properly for future reference. Anyone who operates the device at any time must operate in accordance with the requirements of this manual.

Copyright Declaration

The copyright of this manual belongs to Shenzhen SOFARSOLAR Co., Ltd. Any corporation or individual should not plagiarize, partially cope or fully copy (including software, etc.), not allow to duplication and publishment in any form and any way. All rights reserved, SOFARSOLAR reserves the right of final interpretation. This manual subject to modify according to user's or customer's feedback. Please check our website at <http://www.sofarsolar.com> for lasted version.

Document Updates

V1.0 2023-03-02

- **Outline**

It describes the assembly, installation, commissioning ,maintenance and failure of the product. Please read it carefully before operating.

- **Scope of Validity**

This product user manual describes the installation, electrical connection, debugging, maintenance and troubleshooting of BTS series intelligent battery system. The series includes the following models :



BTS 5K



- **Target Group**

This document is intended for professional electrical engineers who are responsible for battery installation and commissioning, including technical support engineers, system engineers, and electrical engineers

- **Symbols Used**

In order to ensure the personal and property safety of users when using BTS series intelligent battery system, as well as the efficient use of this product, the manual provides relevant safe operation information and highlights it with corresponding symbols. These stressed messages must be fully understood and absolutely adhered to avoid personal injury and property damage. The symbols used in this manual are listed below.

 Danger	“Danger”indicates a hazardous situation which, if not avoided, will result in death or serious injury.
 Warning	“Warning”indicates a hazardous situation which, if not avoided, could result in death or serious injury

 Caution	“Caution” indicates a hazardous situation which, if not avoided, could result in minor or moderate injury
 Attention	“Attention” indicates there are potential risks, if fail to prevent, may lead to equipment cannot normally or property damage.
 Note	“Note” provides additional information and tips that are valuable for the optimal operation of the product, will help you to solve a problem or save your time.

1. Basic Safety Information

Please read the instruction carefully. Faulty operation may cause serious injury or death .



If you have any question or problem when you read the following information, please contact Shenzhen SOFARSOLAR CO, Ltd.

1.1. Requirement for Installation and Maintenance

The installation of BTS series battery module must be in full compliance with national and local laws and regulations.

Read and understand all instructions contained in this manual and familiarize yourself with safety symbols before installing and commissioning the device.

For any maintenance or repair, please contact the nearest authorized repair center. For information about the nearest authorization center, contact your reseller. Do not repair by yourself, which may cause personal injury or property injury.

Before installing and maintaining the device, disconnect the device from the external device using the DC switch. Otherwise, the high voltage may cause serious injury.

SOFARSOLAR will not be responsible for any personal injury or property injury caused by improper use.

Installation and maintenance personnel requirements

The personnel responsible for installation and maintenance of the equipment for the first voyage must first receive strict training, understand various safety precautions and master correct operation methods.

- Only qualified professionals or trained personnel are allowed to install, operate, and maintain the device.
- Only qualified professionals are allowed to remove safety facilities and repair devices.
- The personnel, including the operators, trained personnel, and professional personnel, who operate the equipment should have the special operation qualification required by the local state, such as the qualification of high voltage operation, height climbing, and special equipment operation.
- Only professional or authorized personnel can replace equipment or components (including software).

Note:

- Professional personnel: those who have the training or operation experience of equipment and are able to understand the potential sources and magnitude of hazards in the process of equipment installation, operation and maintenance.
- Trained personnel: personnel who have received the appropriate technical training and have the necessary experience are aware of the risks that may be posed to them in performing a certain operation and can take measures to minimize the risks to themselves or other personnel.
- Operators: operators who may have access to the equipment except trained and professional personnel.

Assembly Condition

Assemble the BTS intelligent battery system as detailed in the following sections of this manual. Place the battery in a position that can be fixed on the edge and ensure that it is placed vertically. A suitable place for installation of electrical equipment should be selected to ensure sufficient

space for fire escape for maintenance in case of failure. Maintain proper ventilation to ensure adequate air circulation for cooling, and air humidity is recommended to be less than <90% during assembly.

Transportation Requirement





The Batteries are in the good electrical and physical condition when it ship out from factory. During transport, battery module must be placed in its original package or other proper package. Transportation company should responsible for any damage during transport period. Please check the battery thoroughly when taking delivery. If you find any packing problems that may cause the damage of inverter or any visible damage, please notice the responsible transportation company immediately. You can ask your installer or SOFARSOLAR for help is necessary.

This product contains battery module through UN38.3, belongs to the ninth category of dangerous goods. Therefore, loading and unloading must comply with local laws and regulations and industry standards during transportation. Rough loading and unloading may cause short circuit or damage to batteries in containers, which may result in battery leakage, breakage, explosion, or fire.

Requirement During the Transportation



- Shipping complies with the IMDG CODE and the International Maritime Dangerous Goods CODE.
- For land transportation, comply with ADR or JT T617 shipping requirements
- Meet the regulatory requirements of the transport regulatory authorities of the country of origin, route and destination.
- Comply with international regulations for the transport of dangerous goods and the supervision requirements of the corresponding national transport regulatory authorities.



1.2. Description of safety information symbols

	High voltage of battery may be harmful to health! Only certified engineer can operate the product; Juveniles, Disable, should not use this product; Keep this product out of the reach of children;
Danger	
	Caution of burn injuries due to hot enclosure! Only touch the screen and pressing key of the product while it is working
Caution	
	Batteries should be grounded in accordance to the requirements of the local electrical grid company
Attention	
	To ensure that the battery is used in the equipment system authorized by SOFARSOLAR, and the battery is damaged or other losses caused by illegal use or unauthorized use of the equipment by SOFARSOLAR. SOFARSOLAR has the right not to do warranty, not to bear joint liability.
Warning	

Sings on the battery module

The battery module carries a number of safety related labels. Make sure to read and understand the labels carefully before installing the device.

Symbols	Name	Explanation
	This is a residual voltage in the battery module!	There is a high voltage,when the battery is powered on. After the battery is powered off, the internal capacitor is still charged, operator should wait for 5 minutes to ensure the capacitor is completely discharged.
	Caution of high voltage and electric shock	The battery module operates at high voltages. Prior to performing any work on the product, disconnect the

		product from voltage sources. Pay attention to the danger of battery voltage during maintenance. All work on the product must be carried out by qualified persons only.
	Caution of hot surface	The battery module can get hot during operation. Avoid contact during operation.
	Grounding Terminal	Connect the battery module to the ground bar for grounding protection
	Observe the documentation	Read all documentation supplied with the product before install

2. Product Introduction

2.1. Product overview

The BTS 5K battery input and output voltages are high DC voltage. The system adopts modular design and stacked installation method. The capacity can be flexibly configured based on actual requirements. The capacity ranges is 5kWh ~ 30kWh. The BTS 5K battery module is not recommended to be used alone, it needs to be used with battery distribution unit (hereinafter referred to as BDU) or ESI series inverter.

The main features are as follows:

- Full modular design, easy to install and transport;
- Current balance between battery modules, higher battery available capacity;
- Capacity Expansion by Stages;
- Low power consumption of battery;

Note:BDU is not a mandatory device for battery use,The following schematic diagram shows the combination of battery and BUD and battery and ESI series inverter.

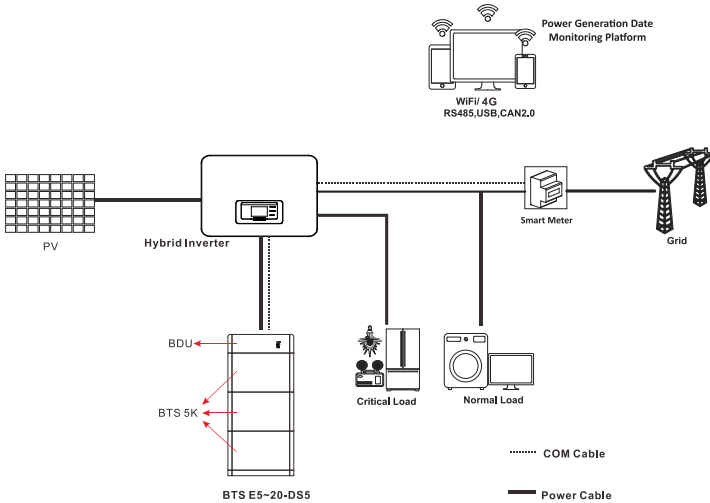

Figure 2.1-1 BTS series application principle diagram

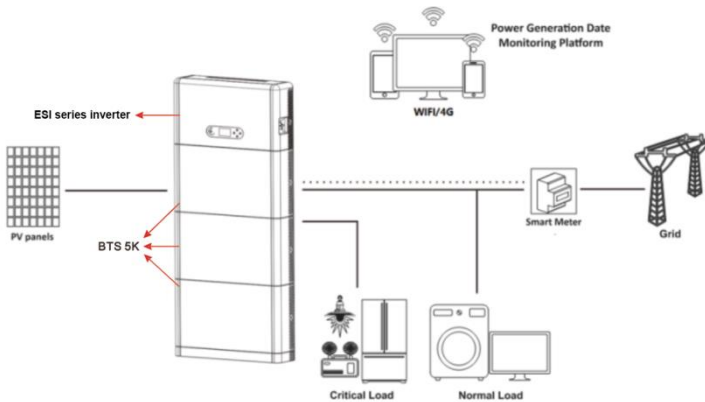

Figure 2.1-2 ESI series application principle diagram

BDU and ESI series inverters are equipped with isolation devices to protect the battery, as shown in the figure below. BDU protective battery disconnecting device: DC switch, fuse. ESI series inverter protection battery disconnecting device: battery input switch.

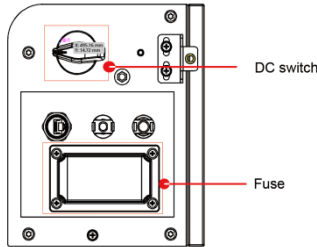

Figure 2.1-3 BDU configuration isolation device

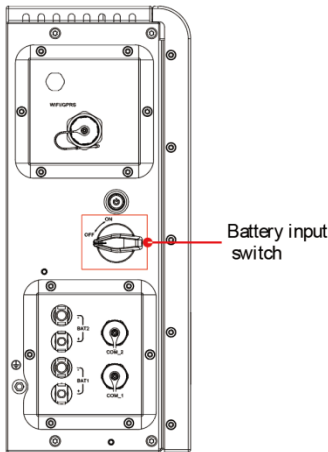

Figure 2.1-4 ESI series inverter configuration isolation device

2.2. Product Model Description

Battery module :

BTS
5K

①
②

Figure 2.2-1 Battery module model identifiers

Table 2.2-1 Battery module model demonstration

Identifiers	Meaning	Specification
-------------	---------	---------------

①	Product series name	SOFARSOLAR BTS series battery module name
②	Battery module energy grade	5K: Battery module energy is 5kWh

2.3. Product Appearance

Battery module port:

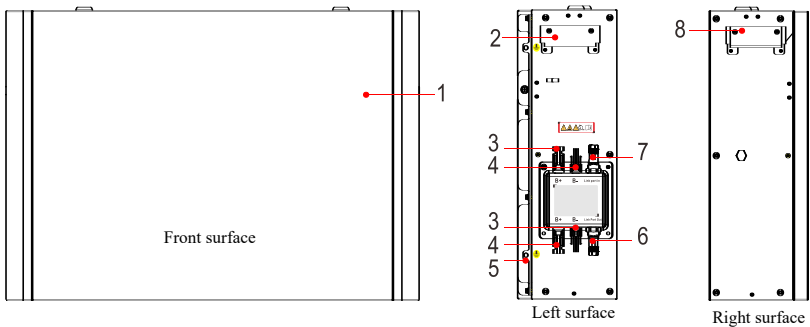

Figure.2.3-1 Battery module port diagram

Table 2.3-1 Battery module port definition

No	Definition	No	Definition
1	Battery module	5	Grounding hole
2	Left side handle	6	Communication output (Link Port Out)
3	Output terminal B+	7	Communication input (Link Port In)
4	Output terminal B-	8	Right side handle

2.4. Product label

Battery module:

IEC designation: IFpP/51/161/120/[1P16S]M/-10+50/90

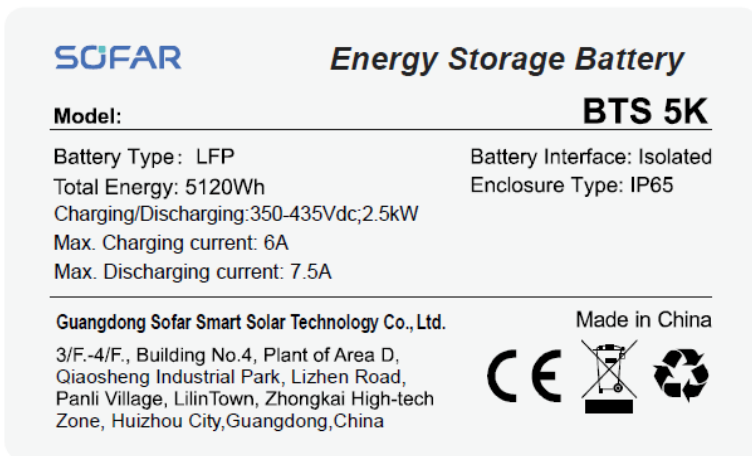





Figure.2.4-1 Battery module label

3. Product Installation

Announcements

	<p>Do not install batteries on flammable materials. Do not install batteries in places where flammable or explosive materials are stored.</p>
<p style="background-color: red; color: white; text-align: center; padding: 2px;">Danger</p>	<p>Do not install batteries out of the range of Installation environment.</p>
	<p>The enclosures and fins are very hot when battery modules is operated, so do not install battery systems where you may inadvertently come into contact with them.</p>
<p style="background-color: yellow; text-align: center; padding: 2px;">Careful</p>	
	<p>Consider the weight of the battery module when transporting and moving it. Select suitable mounting position and surface. At least two persons are required to install battery modules.</p>
<p style="background-color: blue; color: white; text-align: center; padding: 2px;">Attention</p>	

3.1. Checking Before Installation









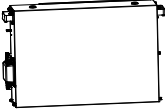
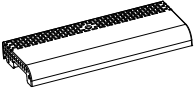
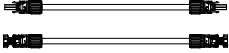

Checking Outer Packing Materials

Packing materials and parts can be damaged in transit. Therefore, check the packing materials of battery modules before installing them. Check whether the outer packing materials are damaged, such as holes and cracks. If any damage is found, please do not open the package and contact the distributor as soon as possible. It is recommended that you remove packing materials within 24 hours before installation.

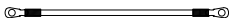
Checking packing list

After the battery modules are unpacked, check whether the packaging and accessories are intact. If any damage is found or any components are missing, contact the distributor.

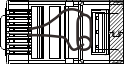
Table 3.1-1 Components and mechanical parts to be delivered for battery modules

No	Pictures	Description	Quantity
1		Battery module	1pcs
2		Protective cover	2pcs
3		Battery power cable	2pcs
4		Battery communication cable	1pcs
5		Anti-tip bracket A	2pcs
6		Side connector	2pcs
7		Anti-tip bracket B	2pcs
8		Ground Cable	1pcs
9		Hexagon screw M6*14	4pcs
10		SEM screws M4*10	10pcs
11		Expansion bolt M6*60	2pcs
12		Terminal resistance	1pcs
13		Quality Certificate	1pcs





14		Manual	1pcs
----	--	--------	------

3.2. Preparation for Installation Tools

Prepare tools for installation and electrical connections.

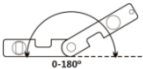
Table 3.2-1 Tools required for installation and electrical connections

No	Tool	Model	Function
1		Hammer drill Recommend Drill @ $\Phi 8\text{mm}$	Used to drill holes on the wall.
2		4mm Screwdriver	Remove and install screws and wires
3		Removal Tool	Remove the output terminal of the battery module and BDU
4		Wire stripper	Used to peel cable
5		Sleeve	Install Fixed support rack
6		Crimping tools	Used to crimp OT connector
7		Heat gun	Used to coated with heat shrinkable casing
8		Multi meter	Check whether the cable connection is correct, the positive and negative terminals of the battery are correct, and the grounding is reliable
9		Marker	Mark signs

10		Measuring tape	Measure distance
11		Level	Ensure the rear panel is properly installed
12		ESD gloves	Installer wear when installing product
13		Safety goggles	Installer wear when drill holes
14		Mask	Installer wear when drill holes

3.3. Installation environment

Before installation, determine the proper position for installing the BTS battery module.

The following requirements must be met:

- Choose a dry, clean, neat and convenient location for installation.
- Machine ambient temperature: $-10^{\circ}\text{C}\sim 50^{\circ}\text{C}$;
- Relative humidity: 5-95% (non-condensing);
- The product should be placed in a well-ventilated place;
- There are no inflammable and explosive objects near the installation position of the product;
- The highest altitude of the installation environment is 4000m.

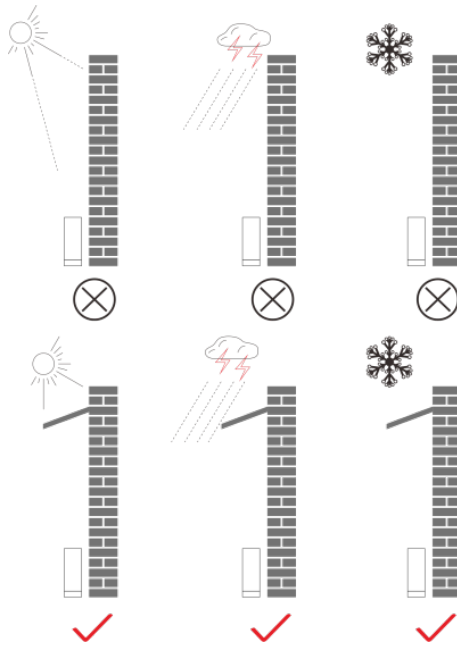

Figure. 3.3-1 Installation Environment Diagram

3.4. Installation Space

To ensure sufficient space for installation and heat dissipation, reserve enough space around the BTS series battery system. The requirements are as follows:

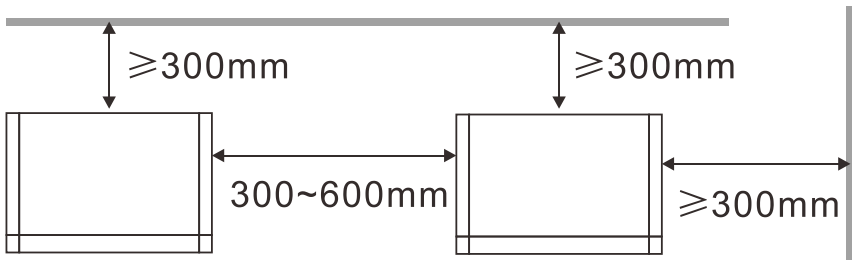

Figure. 3.4-1 Installation space diagram

3.5. Battery module installation

Installation dimensions diagram :

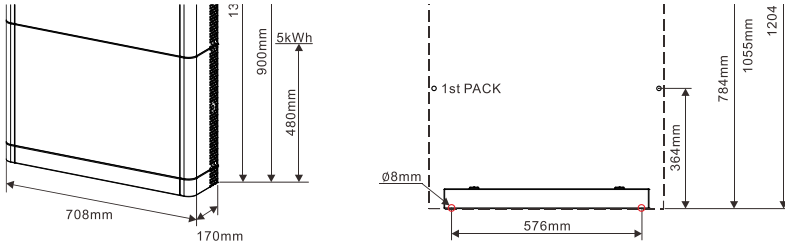

Figure. 3.5-1 System installation dimensions diagram

Base installation

Procedure :

1) Place the base against the wall and keep it 10 to 25 mm away from the wall surface. Use a level to adjust the hole position and mark the hole position with a marker.

2) Remove the base, drill holes using a hammer drill (ϕ 8mm, depth range 60-65 mm), and tighten expansion bolt to ensure that the base is securely installed.

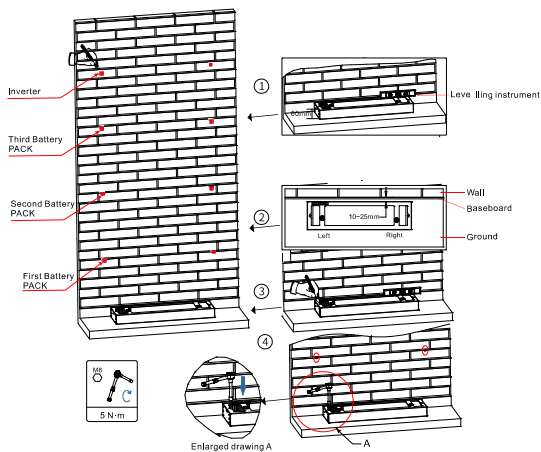

Figure. 3.5-2 base installation diagram

Fixed installation between modules :

Procedure :

- 1) Place the battery module on the base.
- 2) Install connectors on both sides and tighten the six screws with a cross screwdriver.

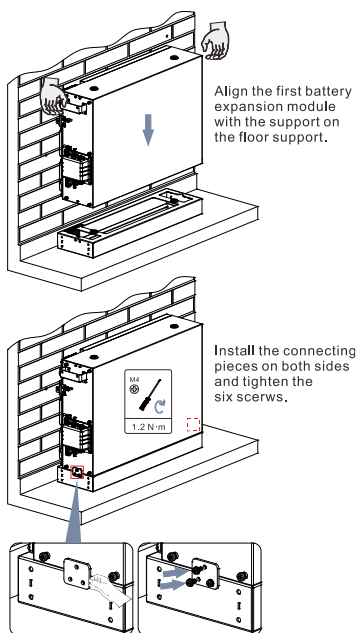

Figure. 3.5-3 Battery module installation diagram

Anti-tip bracket installation :

Procedure :

- 1) Drill holes with a hammer drill (\varnothing 8mm, depth range 60-65 mm). Reposition and drill the holes, if the original one has a large deviation.
- 2) Install the anti-tip bracket B on the wall, and fasten expansion bolt.
- 3) Adjust the anti-tip bracket A, make sure the holes are matched

between anti-tip bracket A and anti-tip bracket B.

4) Connect and fix the anti-tip bracket A and anti-tip bracket B with M6*16 screws.

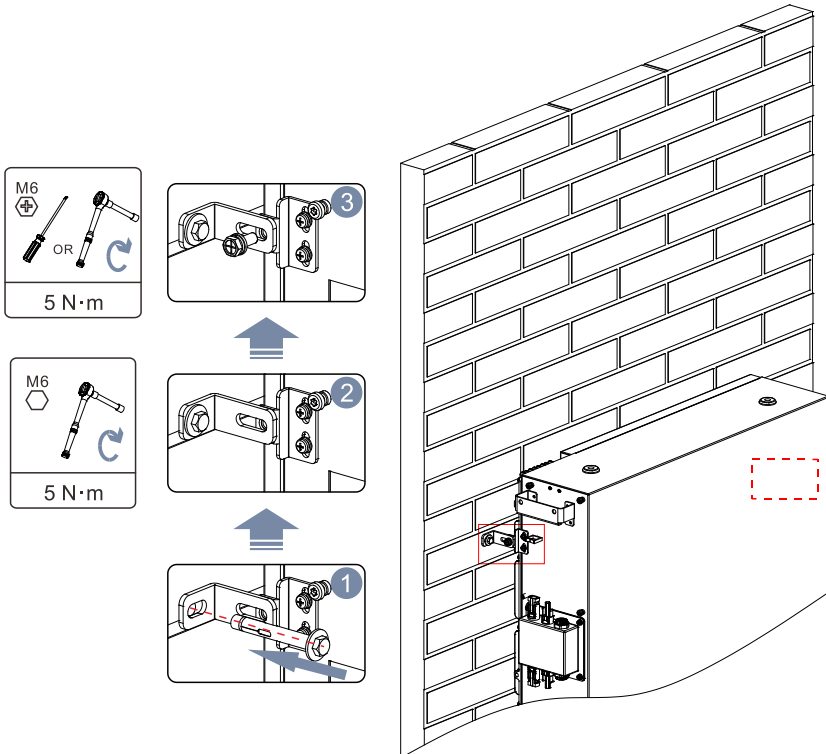





Figure. 3.5-4 Schematic diagram of wall fixing installation

4. Electrical Connection

This product is used for battery energy storage PV system. Equipment can be damaged if not used as intended.

	<p>Only professional electrical engineers can install and maintain batteries. When making electrical connections, wear rubber gloves and protective clothing.</p>
<p>Attention</p>	<p>When connecting the device electrically, you must first connect the protection ground cable. When removing a device, ensure that the PGND cable is removed at last.</p>
	<p>Before electrical connection, ensure that the battery module has no output voltage. Prepare a battery cable and ensure that the positive and negative output polarities of the battery are correct; otherwise, the device may be damaged.</p>
<p>Danger</p>	
	<p>The equipment damage caused by operator's wrong wiring is not covered by the product warranty.</p>
<p>Note</p>	

4.1. Electrical Connection

4.1.1 Protection grounding cable connection

Procedure:

As shown in Figure 4.1.1-1, connect the grounding points between modules with protective grounding cables and ensure reliable connection of grounding cables.

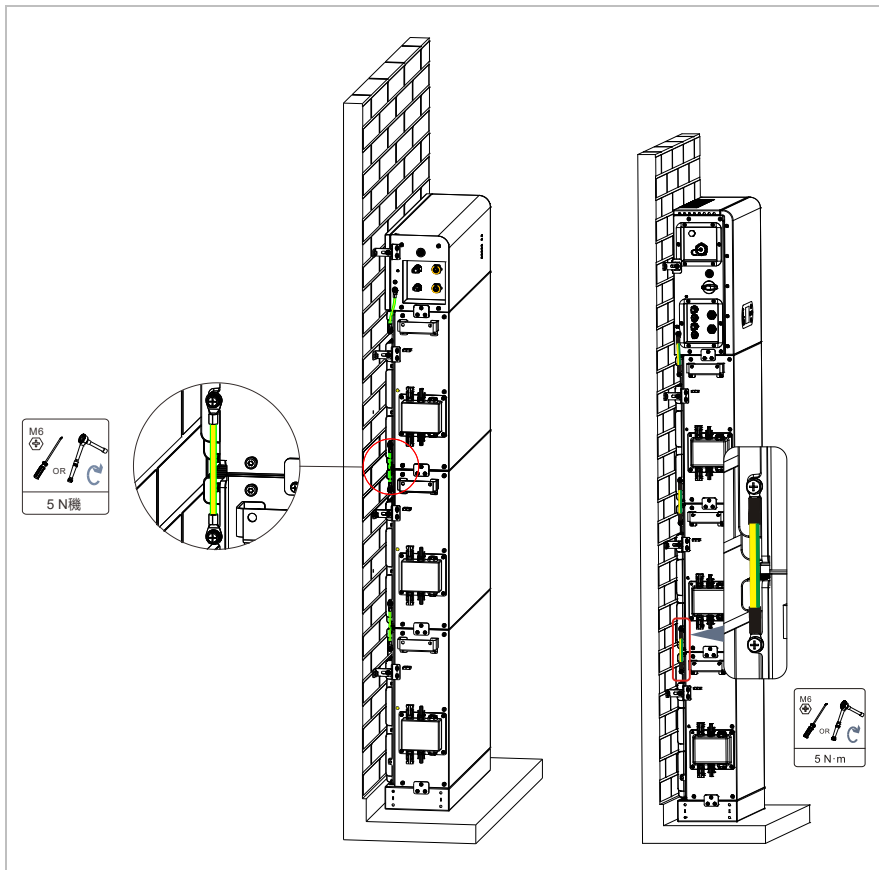

Figure. 4.1.1-1 Grounding cable connection diagram

4.1.2 Power cables connection

As shown in Figure 4.1.2-1, The positive and negative terminals of the battery module are connected , and secure the cables using cable ties. Ensure that the cables are securely .

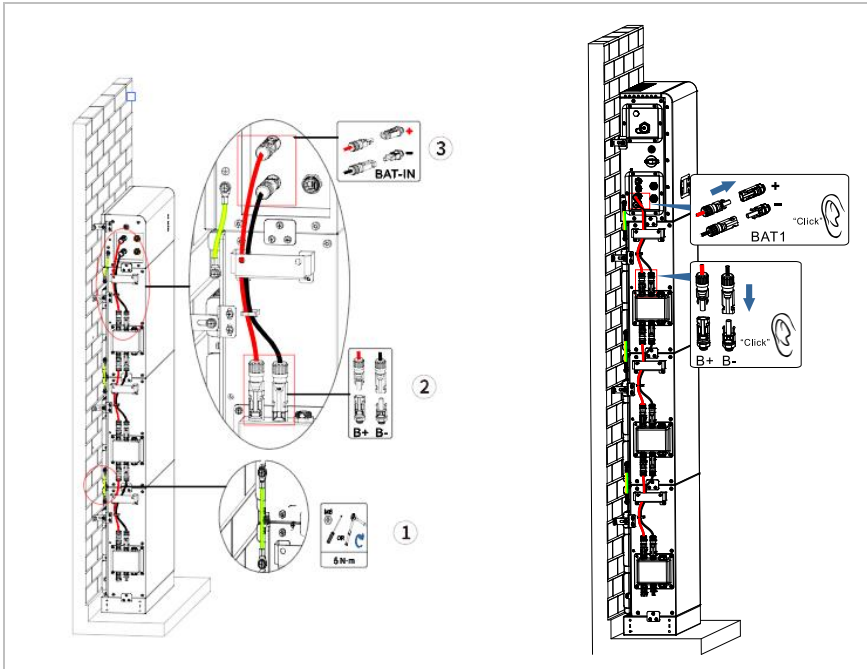

Figure. 4.1.2-1 Diagram of internal power cable connection

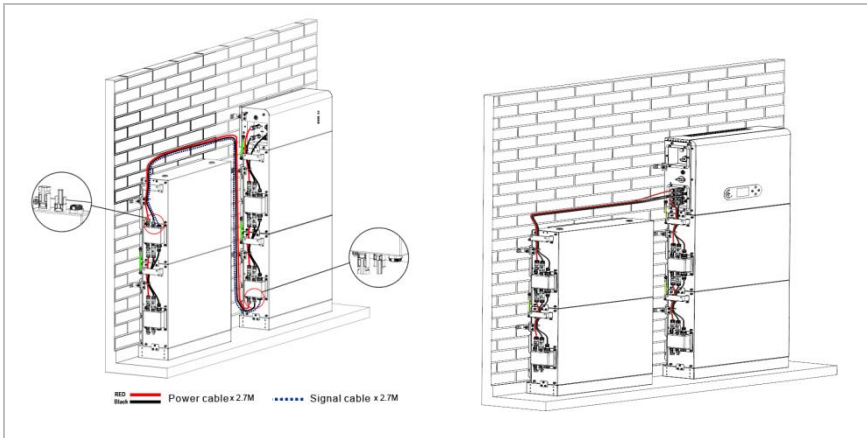

Figure. 4.1.2-2 Battery module 2+2 stack installation mode

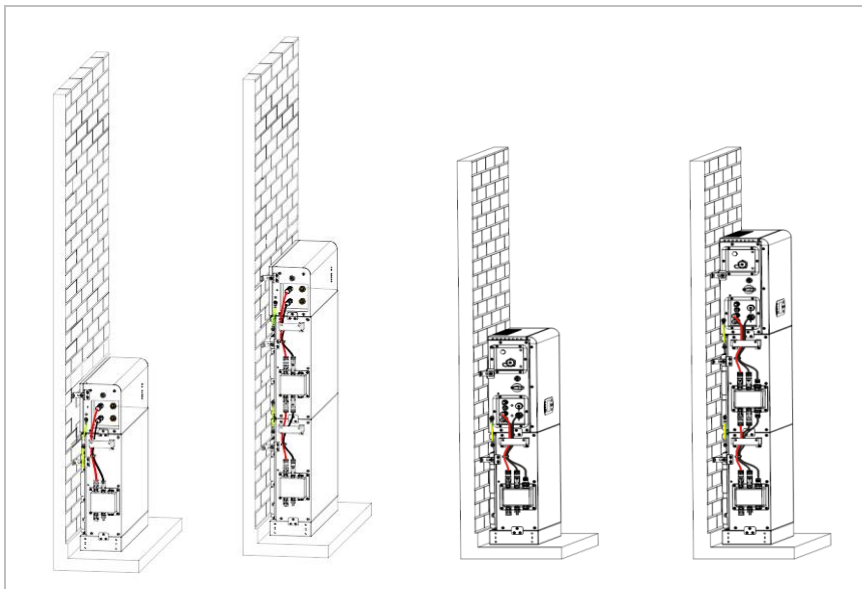

Figure. 4.1.2-3 Installation diagram of different battery quantities

Note:

1. For other combinations, please refer to the official website or contact the local after-sales service.
2. For Australian Market, an overcurrent protection and isolation device that isolates both positive and negative conductors simultaneously is required between the inverter and the battery and also between parallel battery systems. Refer to AS/NZS 5139 for requirements for the disconnection device to see if integrated Switch in BUD and ESI series meets requirements.

4.1.3 Communication cable connection

Procedure:

- 1) The communication cable of the battery are connected in cascade, lock the nut clockwise to ensure reliable connections, and connect the remaining battery modules from top to bottom, and secure them with cable ties.

- 2) Install a terminal resistor on the Link Port Out Port of the last battery module in the system, and lock the nut clockwise to ensure a firm and reliable connection (missing the terminal resistor may cause battery communication failure).

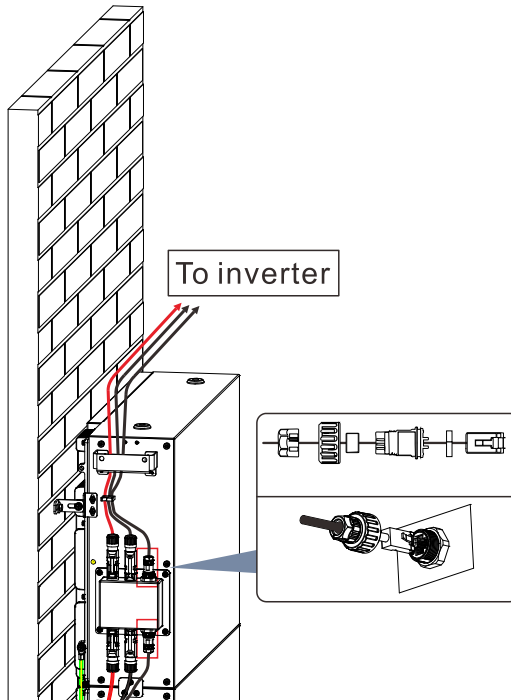

Figure. 4.1.3-1 Diagram of internal signal cable connection

4.2. Install the protective cover

After electrical connections are complete and cable connections are correct and reliable, install the external protective cover.

Procedure:

- 1) Install protective covers on both sides of the base, directly into the base.

- 2) Install protective covers on both sides of the Battery module, tighten the protective cover with screws.

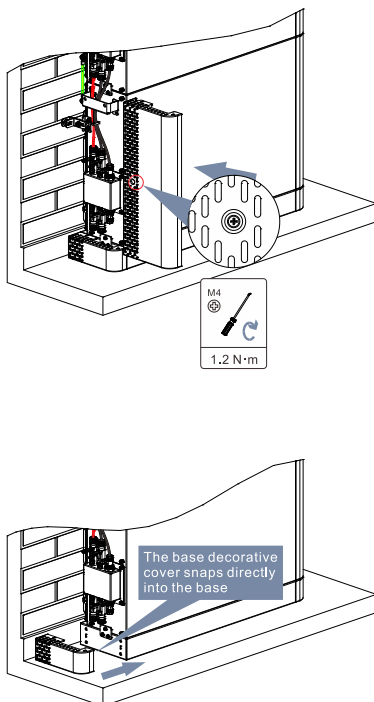

Figure. 4.2-1 Diagram of installing protective cover

5. Commissioning

5.1. Double Check

Please double check the following items before running :

- Battery module and the base should be completely fixed.
- Each BAT+/BAT- line is firmly connected, the polarity is correct, and the voltage is in line with the accessible range.
- The DC switch of the BDU (or ESI Series Inverter) is OFF, and the black start indicator is OFF.
- Ensure that the communication cable is firmly connected to the terminal resistor.
- Install sealing plugs on unused terminals or interfaces.
- Cable is arranged reasonably, and the cable is tidy and without damage.

5.2. Electrify for the First Time (Important)

- 1) Set the DC switch of the BDU (or ESI Series Inverter) to ON.
- 2) Press the black start switch on the BDU (or ESI Series Inverter) to power on the battery for the first time. Observe the LED indicator on the BDU (or ESI Series Inverter) to check the running status.

5.3. Software Update and Battery monitoring

The product can be upgraded through the software of SOFARSOLAR ESI Series Inverter to maximize the performance of the product and avoid the abnormal operation of the product caused by software bugs.

Before upgrading the software, check that the communication cables of

the system and the DC power cables of the battery are properly connected, and ensure that the system has reliable power supply from utility or PV during the upgrade.

Procedure:

- 1) Insert the USB drive into the computer.
- 2) The upgrade file folder is named firmware. After receiving the upgrade file, decompress it and save it in a USB disk.
- 3) Insert the USB disk into the USB/Wifi interface of the energy storage inverter .
- 4) Set the DC switch of the battery distribution unit to "ON state", press the black start switch, and the energy storage inverter and battery start up and run.
- 5) Perform the following operations on the LCD of SOFARSOLAR ESI series energy storage inverter:

6.Software Update	Enter Password	Enter 0715	1.PCS Updating	Start Updating
			2.BMS Update	Updating BMS
			3.PCU Update	Updating PCU

- 6) If the following error occurs, upgrade again. If this situation persists for several times, contact technical support for help.

USB error	PCU file error	BMS file error
ARM file error	Upgrading PCU fail	Upgrading BMS fail
Upgrading ARM fail		

- 7) After the upgrade is complete,you can view the current software version in System Info >> Software Version.

Monitor battery information

Perform the following operations on the LCD of SOFARSOLAR ESI series energy storage inverter to monitor battery information:

Enter the selection menu --- select Battery real-time info --- select BMS info/PCU info

7.Battery real-time Info	BMS Info	Batt 0.0V Batt Curr. 0.00A Max Charge 0.00A
	PCU Info	PCU low voltage 0.0V PCU high voltage 0.0V PCU low power 0.00kW

5.4. Battery Powered Off

- 1) Press the black start switch of BDU(or ESI Series Inverter).
- 2) Set the DC switch of the BDU(or ESI Series Inverter)to OFF. All the LED indicators on the battery distribution box are OFF. After the system is powered OFF for five minutes, ensure that the remaining battery charges are discharged before performing maintenance.

6. Trouble shooting and maintenance

6.1. Troubleshooting

This section describes the potential errors for this product. Please read carefully for the following tips when doing the troubleshooting:

- 1) For details about the warning or error information displayed on the BDU(or ESI Series Inverter)status indicator.
- 2) When the battery generates an alarm or error message, the alarm report is uploaded to the inverter. You can determine the cause of battery alarms or faults by viewing the inverter display or the monitoring system.
- 3) Perform the following steps to check whether the current installation status meets the battery operating requirements:
 - Is the battery installed in a clean, dry, well-ventilated location?
 - Check whether the battery DC switch is off?
 - Check whether the cable section and length meet requirements?
 - Is the wiring good?
 - Whether the configuration Settings are correct for the user's specific installation?
 - Whether the communication cable is correctly connected and is not damaged?

6.2. Daily Maintenance

 Attention	After the battery is powered off for 5 minutes, ensure that the capacitor inside the battery is discharged before maintenance.
---	--

Batteries usually do not require maintenance or calibration, but ensure that the radiator is not covered with dust, dirt, etc.

Clean the battery module

Please clean the battery module with an air blower, a dry & soft cloth or a soft bristle brush. Do not clean the inverter with water, corrosive chemicals, detergent, etc.

6.3. Battery Module Storage Requirements and Power Supply

Battery Module Storage Requirements:

- Environment temperature: $-10^{\circ}\text{C}\sim 45^{\circ}\text{C}$, Recommended storage temperature: $25^{\circ}\text{C}\sim 35^{\circ}\text{C}$.
- Storage relative humidity range: 5%~70%.
- Store in a dry, clean, and ventilated environment, away from direct sunlight.
- When storing the battery module, place it correctly. Do not put the battery module upside down or on its side.
- If the battery module is stored for a long time, replenish the power supply periodically. Battery module power supply requirements: the charging current is less than or equal to 7A, and the battery module needs to be charged to 50%SOC.

Recharge Requirements During Normal Storage

When the battery is stored for a long time, you need to perform regular maintenance. If the storage time is close to that shown in the following table, arrange supplementary power supply in time.

Recharge conditions when in storage

Storage Environment Temperature	Relative Humidity of Storage Environment	Storage Time	SOC
< -10℃	/	Prohibit	/
-10℃~25℃	5%~70%	≤12 months	30%≤SOC≤60%
25℃~35℃	5%~70%	≤6 months	30%≤SOC≤60%
35℃~45℃	5%~70%	≤3 months	30%≤SOC≤60%
> 45℃	/	Prohibit	/

Recharge Requirements When Over Discharged

Recharge the battery within the time range specified in the following table (90%DOD). Otherwise, the over discharged battery module will be damaged.

Recharge conditions when battery is over discharged

Storage Environment Temperature	Storage Time	Note
-10℃~25℃	≤15 days	/
25℃~45℃	≤7 days	30%≤SOC≤60%
-10℃~45℃	≤12 hours	/

7. Technical Parameters

Technical parameters	
Model	BTS 5K
Battery Type	LFP
Rated capacity	100Ah
Voltage Range	300~435V
Total Energy[1]	5120Wh
Usable Energy[2]	4750Wh
Depth of discharge (DOD)	90%
Nominal Power	2500W
Max. Charging Current	6A
Max. Discharging Current	7.5A
Dimension(W*D*H)	708*170*420mm
Weight	50kg
Degree of protection	IP65

Discharge temperature range[3]	-10°C~+50°C
Charge temperature range[3]	0°C~ 50°C
Allowable relative humidity range	5~95%
Communication	CAN
Compatible Inverters	Refer to BTS 5K Configuration List

[1] Test conditions: 100% DOD, 0.2C charge & discharge at + 25°C.

[2] Usable Energy is based on battery cell only.

[3]Refer to the temperature derating curve.

8. Manufacturer's Warranty and Liability Terms

Warranty period

Warranty period and calculation method of SOFARSOLAR battery products refer to the Quality Assurance Agreement of SOFARSOLAR BTS Series battery module.

Extended warranty period

If the purchased battery exceeds the warranty period stipulated in the Warranty Agreement of SOFARSOLAR BTS Series battery module, the customer can apply for the extended warranty period by providing the serial number of the product to the sales team of the company, and the Company has the right to reject the purchase application for the extended warranty period that does not meet the requirements.

If the original buyer wants to apply for the extended warranty service, please contact the sales team of Shenzhen SOFARSOLAR Co., LTD to purchase the products that exceed the extended warranty period but have not passed the warranty period stipulated in the Warranty Agreement of SOFARSOLAR BTS Series battery module, the original buyer shall bear different extended premiums.

Upon purchase of the extended warranty service, our company will issue an extended warranty card to the customer to confirm the extended warranty period.

Invalid warranty clause

Equipment failure caused by the following reasons is not covered by the warranty:

- 1) The "warranty card" has not been sent to the distributor or Shenzhen SOFARSOLAR Co., LTD;
- 2) Without the consent of Shenzhen SOFARSOLAR Co., LTD to change equipment or replace parts;
- 3) Use unqualified materials to support Shenzhen SOFARSOLAR Co., LTD 's products, resulting in product failure;
- 4) Technicians who don't belong to SOFARSOLAR Co., LTD modify or attempt to repair and erase the product serial number or silk screen;
- 5) Incorrect installation, debugging and use methods;
- 6) Failure to comply with safety regulations (certification standards, etc.);
- 7) Damage caused by improper storage by dealers or end users;
- 8) Transportation damage (including scratches caused by internal packaging during transportation).Please claim directly from the transportation company or insurance company as soon as possible and obtain damage identification such as container/package unloading;
- 9) Failure to follow the product user manual, installation manual and maintenance guidelines;
- 10) Improper use or misuse of the device;
- 11) Poor ventilation of the device;
- 12) The product maintenance process does not follow relevant standards;
- 13) Failure or damage caused by natural disasters or other force (such as earthquake, lightning strike, fire, etc.)



ENERGY TO POWER YOUR LIFE

ADDRESS

11/F., Gaoxinqi Technology Building,
Xingdong Community, Xin'an Sub-district,
Bao'an District, Shenzhen City, China

EMAIL

info@sofarsolar.com

WEBSITE

www.sofarsolar.com



301.00000403-0